

Qty. Description

1 **UPS 25-60 180**



Note! Product picture may differ from actual product

Product No.: On request

The pump is of the canned rotor type, i.e. pump and motor form an integral unit without shaft seal and with only two gaskets for sealing.

The bearings are lubricated by the pumped liquid.

Speed no: The pump has 3-step speed selector.

The pump is characterized by:

- * Ceramic shaft and radial bearings.
- * Carbon axial bearing.
- * Stainless steel rotor can and bearing plate.

Impeller: * Corrosion-resistant impeller, Composite, PES/PP.

Pump housing: * Cast iron pump housing.

Phase: The motor is a 1-phase motor.

No additional motor protection is required.

Liquid:

Pumped liquid: Water

Liquid temperature range: 2 .. 110 °C

Selected liquid temperature: 60 °C

Density: 983.2 kg/m³

Technical:

TF class: 110

Approvals on nameplate: CE

Materials:

Pump housing: Cast iron
EN-JL1030
ASTM 30 B

Impeller: Composite, PES/PP

Installation:

Amb. max at 80 dgr C liquid: 40 °C

Maximum operating pressure: 10 bar

Pipe connection: G 1 1/2

Pressure rating: PN 10

Port-to-port length: 180 mm

Electrical data:

Power input in speed 1: 50 W

Power input in speed 2: 60 W

Max. power input: 70 W

Mains frequency: 50 Hz

Rated voltage: 1 x 230 V

Current in speed 1: 0.22 A

Current in speed 2: 0.27 A

Current in speed 3: 0.3 A

Qty.	Description
------	-------------

	Capacitor size - run: 2.5 μ F
	Enclosure class (IEC 34-5): IP44
	Insulation class (IEC 85): F
	Others:
	Net weight: 2.6 kg
	Gross weight: 2.8 kg
	Shipping volume: 0.004 m ³

On request UPS 25-60 180 50 Hz

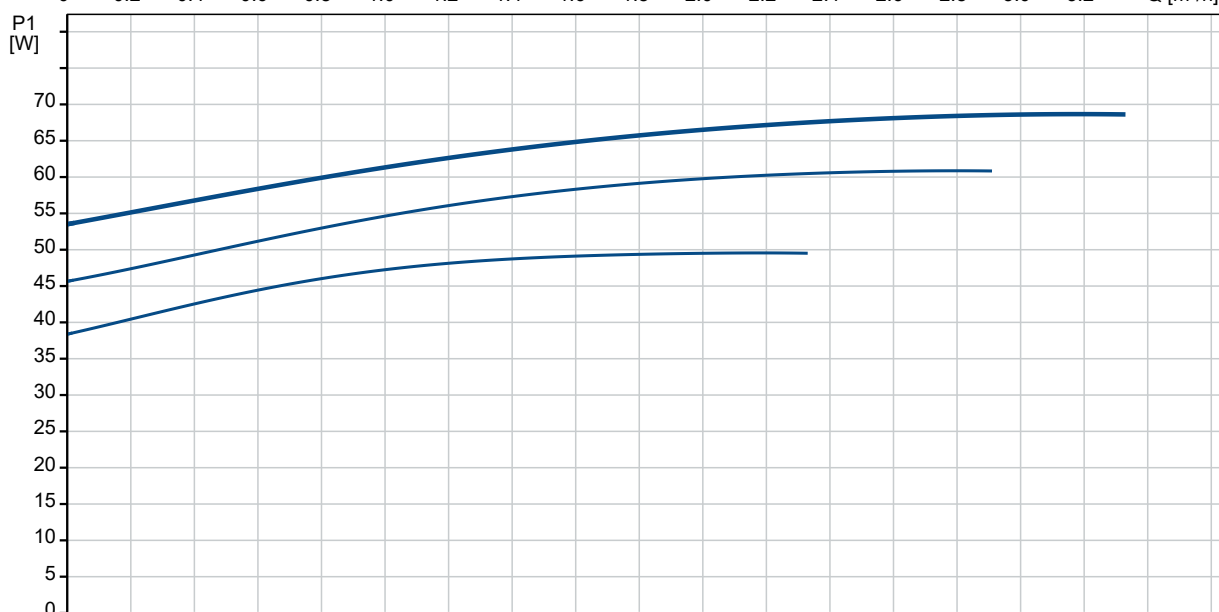
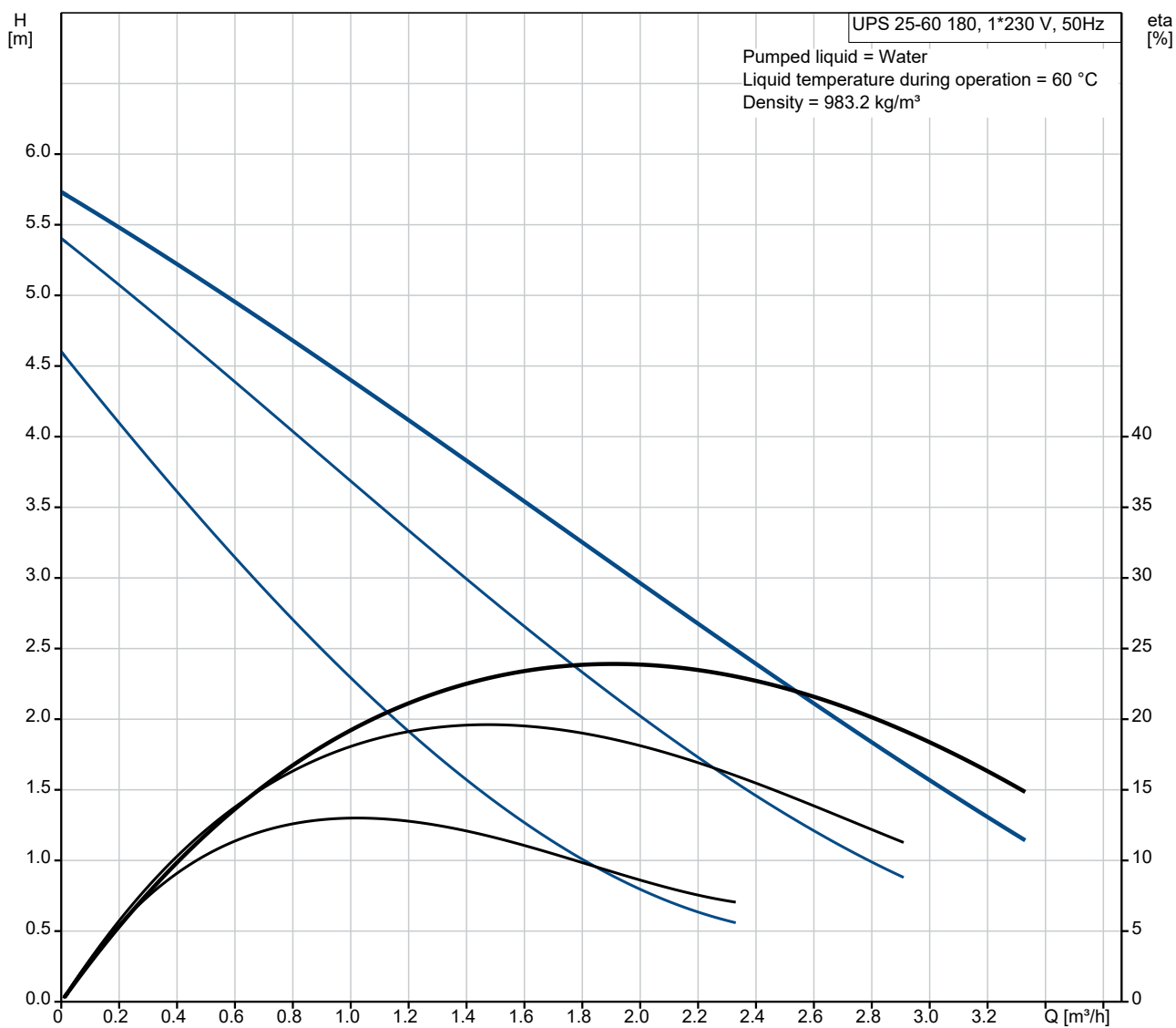

Description	Value
General information:	
Product name:	UPS 25-60 180
Product No:	On request
EAN number:	On request
Price:	
Technical:	
Speed no:	3
Head max:	60 dm
TF class:	110
Approvals on nameplate:	CE
Materials:	
Pump housing:	Cast iron
Pump housing:	EN-JL1030
Pump housing:	ASTM 30 B
Impeller:	Composite, PES/PP
Installation:	
Amb. max at 80 dgr C liquid:	40 °C
Maximum operating pressure:	10 bar
Pipe connection:	G 1 1/2
Pressure rating:	PN 10
Port-to-port length:	180 mm
Liquid:	
Pumped liquid:	Water
Liquid temperature range:	2 .. 110 °C
Selected liquid temperature:	60 °C
Density:	983.2 kg/m ³
Electrical data:	
Power input in speed 1:	50 W
Power input in speed 2:	60 W
Max. power input:	70 W
Mains frequency:	50 Hz
Rated voltage:	1 x 230 V
Current in speed 1:	0.22 A
Current in speed 2:	0.27 A
Current in speed 3:	0.3 A
Capacitor size - run:	2.5 µF
Enclosure class (IEC 34-5):	IP44
Insulation class (IEC 85):	F
Motor protec:	NONE
Thermal protec:	Impedance protected
Controls:	
Pos term box:	9H
Others:	
Net weight:	2.6 kg
Gross weight:	2.8 kg
Shipping volume:	0.004 m ³

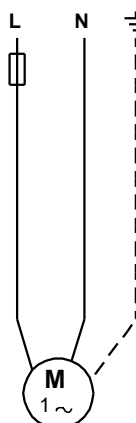
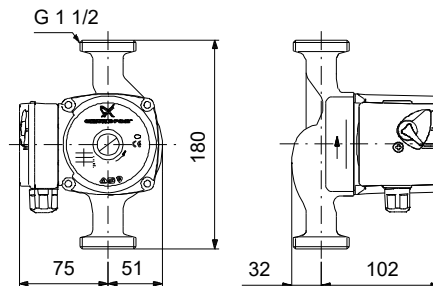
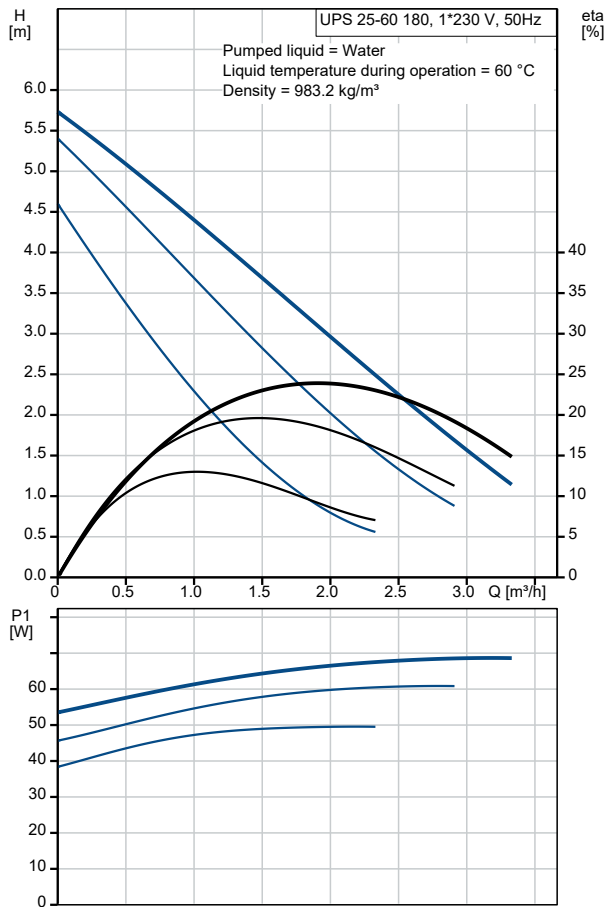

On request UPS 25-60 180 50 Hz

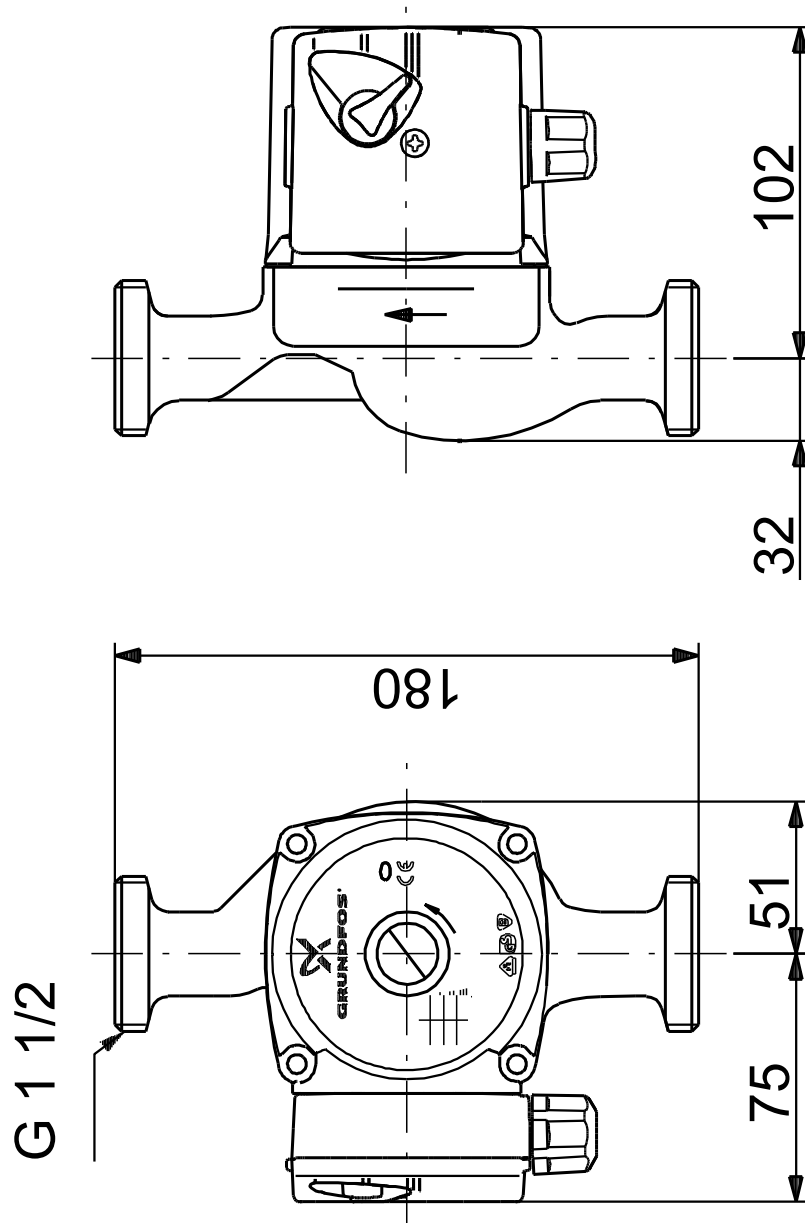

Note! All units are in [mm] unless others are stated.
Disclaimer: This simplified dimensional drawing does not show all details.

On request UPS 25-60 180 50 Hz

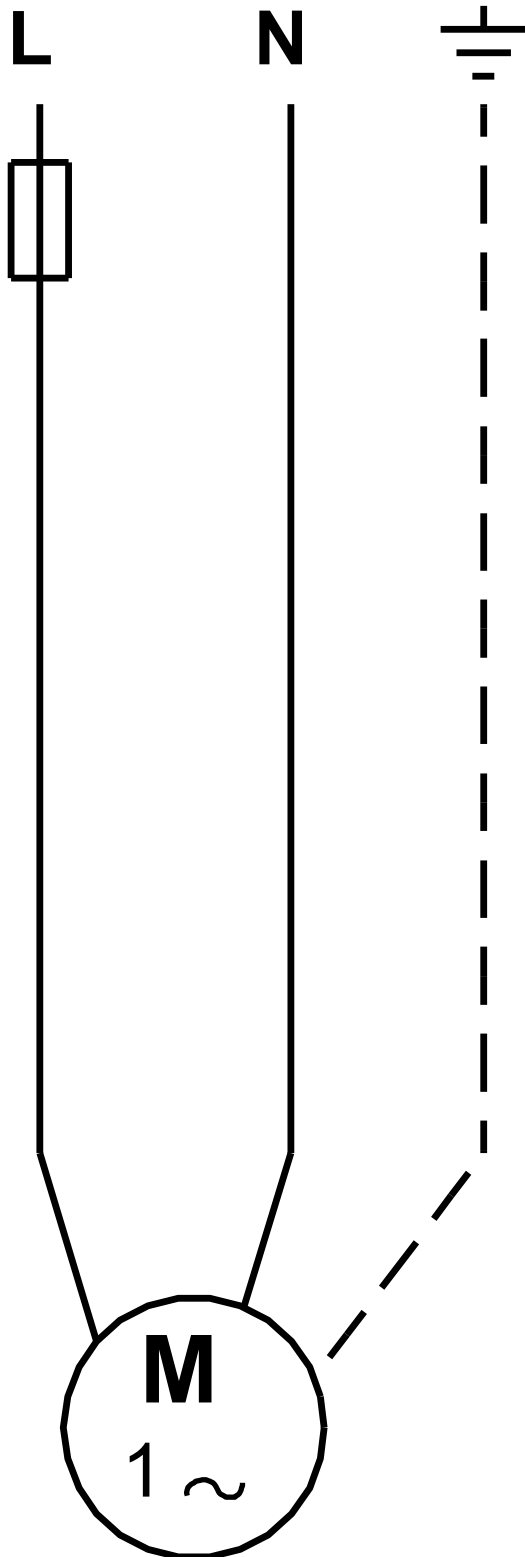

Note! All units are in [mm] unless others are stated.